

*The best way
to cut & groove*

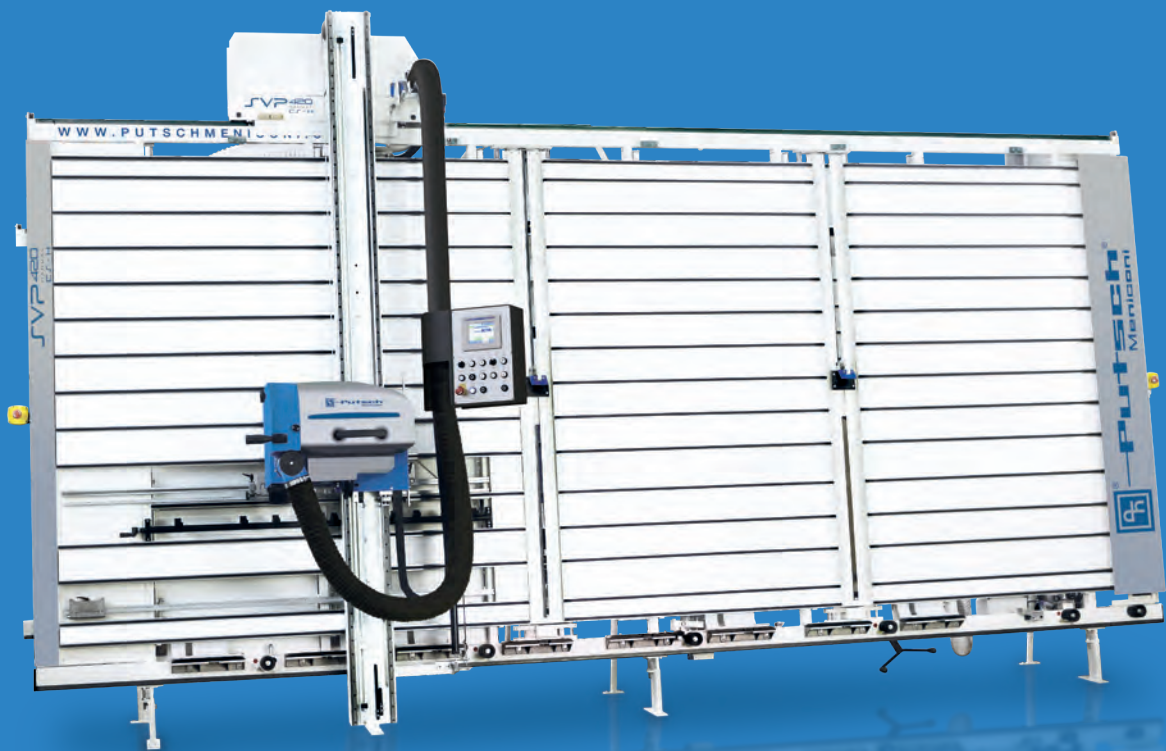

SVP 420
AUTOMATIC
CS - H
100% MADE IN ITALY

TECHNOLOGY | RELIABILITY | INNOVATION
TECNOLOGÍA | CONFIABILIDAD | INNOVACIÓN



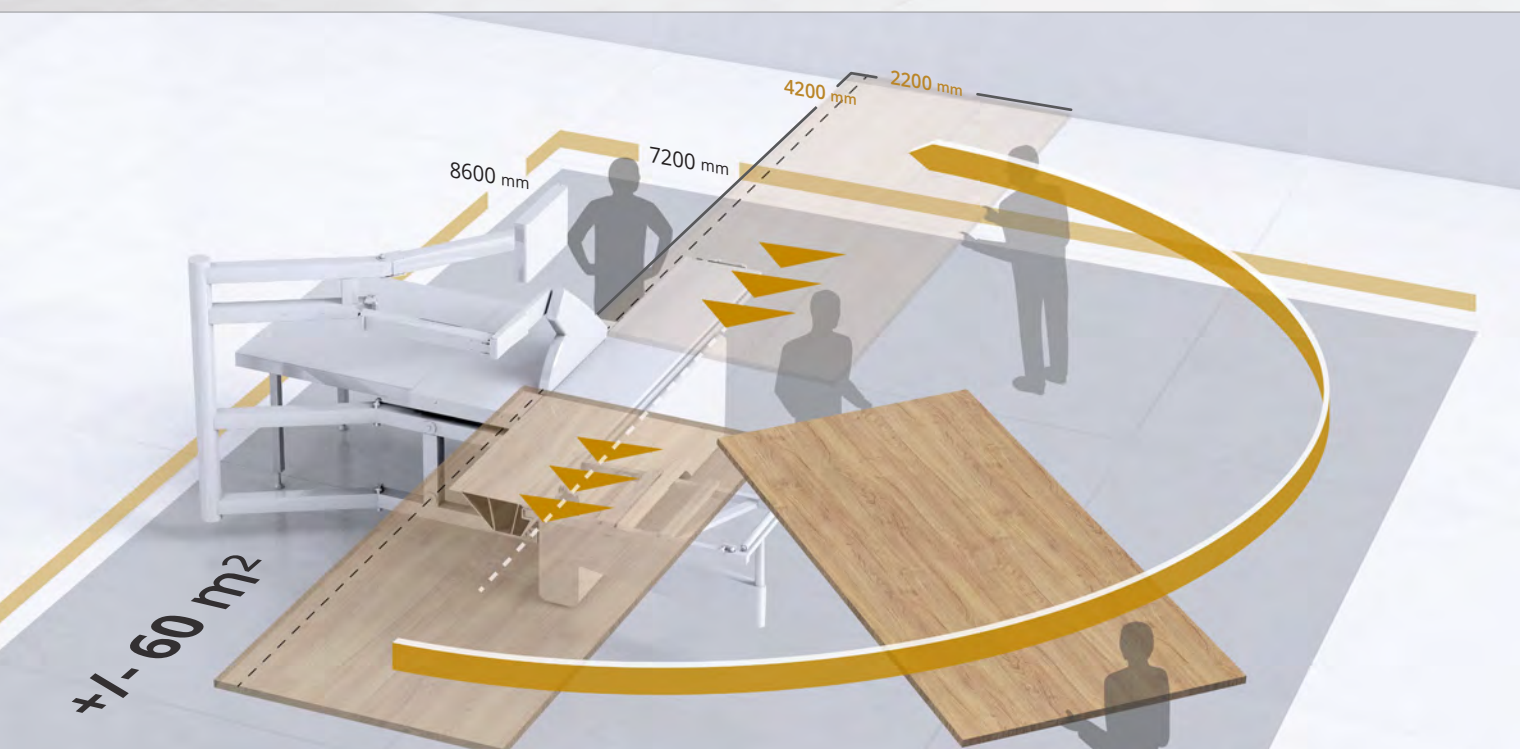
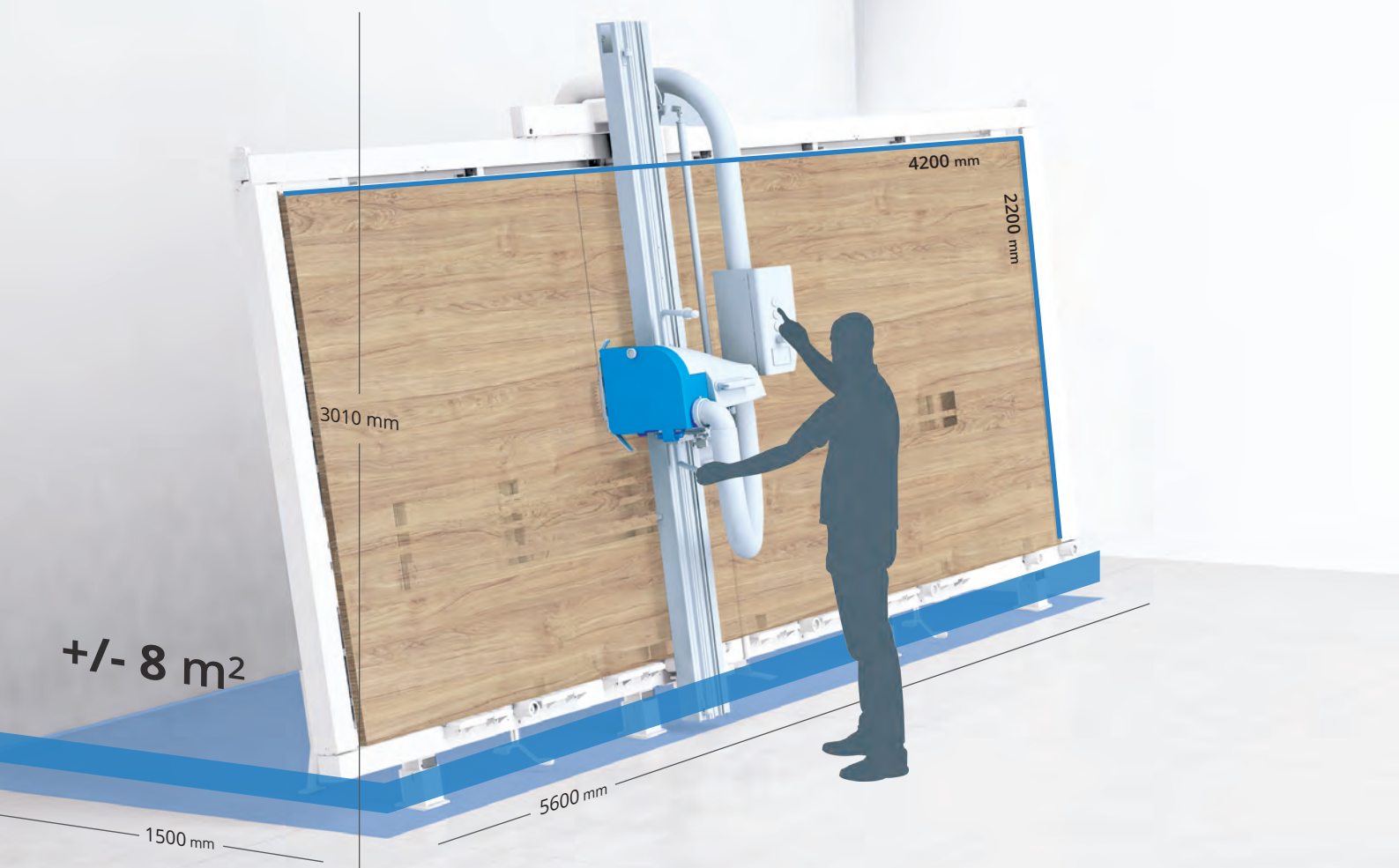

The comparison with a sliding table saw shows how this machine requires at least 2 people to manage the cutting of large panels and how the area required increases considerably during the work.

La comparación con una escuadradora clásica muestra cómo esta máquina requiere por lo menos 2 personas para manejar el corte de grandes paneles y que el volumen de espacio aumenta considerablemente durante el trabajo.



MAXIMUM SAFETY AND RELIABILITY
MÁXIMA SEGURIDAD Y CONFIABILIDAD



HIGH PERFORMANCES
ALTO RENDIMIENTO



PROFITABLE AND LASTING INVESTMENT
INVERSIÓN RENTABLE Y DURADERA



SPACE SAVER
DIMENSIONES REDUCIDAS

Why choose a Putsch Meniconi Vertical Panel Saw

Reduced dimensions

Unlike traditional sliding table, vertical panel saw have small sizes and occupy minimal production areas, because it uses heights as a work area. Thanks to a special layout it only occupies one wall, easily adapting to small rooms, to meet the most diversified customer needs.

Maximum safety and reliability

Vertical panel saw is a safer tool than sliding table, because its covered saw blade always avoids direct contact between operator, blade carriage and materials in every phase of process. In the automatic version, after positioning the panel and setting dimensions, the operator can simply supervise the cutting phase, further increasing the level of safety and optimizing working times.

Profitable and lasting investment

The excellent quality / price ratio makes vertical panel saw a profitable investment even for companies with small staff. Just an operator is able to complete the job, whereas a sliding table would require at least two to move the panels. Vertical panel saw is a long lasting and versatile product, suitable for cutting different materials, and highly customizable thanks to the available optionals.

High Performances

Vertical panel saw achieves results difficult to match with traditional machines. Saw heads run on linear guides, so it guarantees highest accuracy and precision, rapidity of execution and ease of use even during the most complex phases. If assembled by our authorized technicians and in optimal environmental conditions, Putsch Meniconi vertical panel saw reaches a tolerance of only 0.1mm per meter. Finally, not having to move the panel by hand, you avoid scratches and imperfections that could compromise the final result.

Porqué elegir una seccionadora vertical Putsch Meniconi

Dimensiones reducidas

A diferencia de la escuadradora clásica, la seccionadora vertical tiene dimensiones más pequeñas y ocupa un mínimo espacio interno porque utiliza la altura como área de trabajo. Gracias a su diseño, solo ocupa una pared, y se adapta fácilmente al lugar de trabajo de pequeña escala para satisfacer las necesidades más diversas de los clientes.

Máxima seguridad y confiabilidad

La seccionadora vertical es una máquina mas segura que la máquina escuadradora, ya que su protector de la sierra siempre evita el contacto directo entre el operador, el carro hojas y los materiales en cada fase del proceso. En la version automática, después la colocación del panel y la configuración de las dimensiones, el operador puede simplemente supervisar la fase de corte, aumentando el nivel de seguridad y optimizando los tiempos de trabajo.

Inversión rentable y duradera

La excelente relación calidad / precio hace que la seccionadora vertical sea una inversión ventajosa incluso para empresas con poco personal. Solo un operador puede ejecutar el trabajo, mientras una máquina escuadradora requeriría al menos dos personas para mover los paneles. La seccionadora vertical es un producto duradero y versátiles, adecuado para cortar diferentes materiales y altamente personalizable gracias a la posibilidad de agregar numerosas opciones.

Alto rendimiento

La seccionadora vertical logra resultados difíciles de igualar con las escuadradoras clásicas. La estabilidad del panel está asegurada por soportes de bases de aluminio cubiertos de polizeno que aseguran firmeza en el corte y garantizando la máxima precisión. Además garantiza una rapidez de ejecución y facilidad de uso incluso la máxima seguridad durante las operaciones de corte. La seccionadora vertical armada por nuestros técnicos autorizados y en optimas condiciones ambientales, garantiza una tolerancia de solo 0,1 mm por metro. La ventaja de utilizar una seccionadora vertical es también el hecho que se evita el desplazamiento del tablero para los cortes verticales y horizontales que podria dañar los tableros mismos y afectar el acabado.

SVP 420
AUTOMATIC
CS-H
100% MADE IN ITALY



Electrowelded frame
Bastidor electrosoldado



Aluminum lower supports coated in polyzene with retractable rollers
Soportes inferiores de aluminio recubiertos de polizeno con ruedas retráctiles



Automatic shifting frame
Parrilla móvil automática



Automatic cut execution
Ejecución corte automático



Saw carriage sliding along two linear guides
Deslizamiento del carro a lo largo de dos guías lineales



Display touch screen for cut guide
Pantalla táctil



Clamping system
Sistema de pinzas



Scoring unit with split saw blade
Grupo incisor de doble sierra



Scoring unit with independent motor
Motor independiente por el grupo incisor



From almost 60 years of cutting experience, we introduce a new vertical panel saw that offers the possibility to trim also the panel bottom part to avoid heavy rotation operations. The special clamps are Putsch Meniconi exclusive system. The clamps are positioned at distance to allow the lifting of heavy and large panels.

A partir de la experiencia de casi 60 años en máquinas seccionadoras, se añade una nueva seccionadora vertical que ofrece la posibilidad de recortar la parte inferior de los tableros, evitando así las incómodas operaciones de rotación de los ableros para que se puedan recortar la parte inferior de los mismos. Las pinzas están colocadas a una distancia tal para permitir el levantamiento de los tableros pesados y grandes.

OVERALL SIZES AND CUTTING CAPACITY / DIMENSIONES Y CAPACIDADES DE CORTE

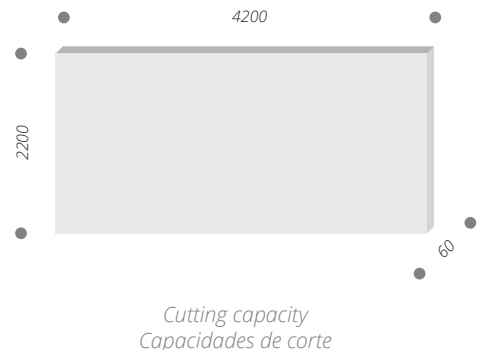
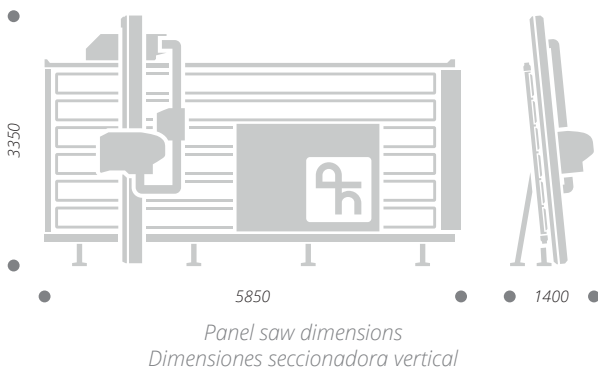

CUTTING MATERIALS / CORTE MATERIALES

SVP 420 AUTOMATIC CS H is designed for wood - special - plastics materials cutting.
SVP 420 AUTOMATIC CS H está diseñada para cortar madera - materiales especiales - plásticos

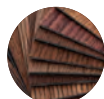

Wood Panels
Paneles de madera



Special Materials
Materiales especiales



Trespa®



Insulated panels
Paneles aislantes



Corian®



Plasterboard
Pladur

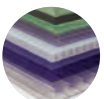

Plastic materials
Plásticos



Linear guides
Dos guías prismáticas

Sliding of saw carriage along two linear guides that allows a better precision

Deslizamiento del carro a lo largo de dos guías prismáticas

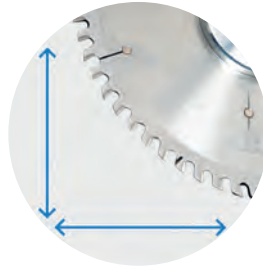

Automatic vertical horizontal cuts
Cortes automáticos verticales y horizontales

Automatic cuts program with differential speed for the return of carter on starting point

Cortes automáticos con velocidad diferencial para el corte y retorno del cabezal al punto de partida

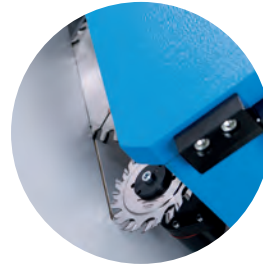

Scoring unit with split saw blade
Incisor de doble sierra

Scoring unit with double saw blade creates a pre-cutting and allows a cutting more precise and faster.

El grupo incisor de doble sierra actúa un pre-corte y permite un acabado más limpio.

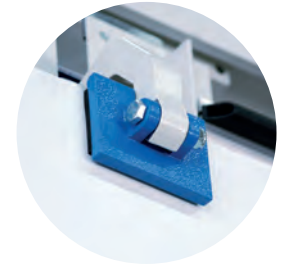

Clamping system
Sistema de pinzas

System of steady clamps, that allows the lifting of panels to make trimmings on lower parts

Sistema de pinzas, que permite el levantamiento de paneles para recortar la parte inferior de los tableros



TECHNICAL DETAILS / DATOS TECNICOS

● Standard Standard ○ Optional Opcional ✕ Unavailable No disponible

TECHNICAL DETAILS / DATOS TECNICOS

| | |
|--|---|
| Motor output <i>Potencia del motor</i> | 6 HP |
| Blade diameter <i>Diámetro de la hoja</i> | 250 mm |
| Blade r.p.m. (min) <i>Rev. de la hoja</i> | 5300 |
| Shifting frame <i>Parrilla móvil</i> | electric <i>eléctrica</i> |
| Aluminum supports with polyzene and wheels <i>Soportes de aluminio recubiertos de polizeno y ruedas</i> | ● |
| Max. length of horizontal cut <i>Máximo largo de corte horizontal</i> | 4200 mm |
| Max. height of vertical cut <i>Máxima altura de corte vertical</i> | 2200 mm |
| Max. height of horizontal cut <i>Máxima altura de corte horizontal</i> | with dampers / sin pinzas - 2080 mm without dampers / con pinzas - 2030 mm |
| Max depth of cut <i>Máximo grueso de corte</i> | 60 mm |
| Scoring blade diameter <i>Diámetro de hoja incisor</i> | 80 mm |
| Independent motor of scoring unit <i>Motor independiente del grupo incisor</i> | ● |
| Motor output of scoring unit <i>Potencia motor grupo incisor</i> | 0,25 HP |

ACCESSORIES AND OPTIONALS / ACCESORIOS Y OPCIONALES

| | |
|---|---|
| Supplementary low level stop <i>Tope suplementario</i> | ○ |
| Extra short cutting device (RH) <i>Dispositivo corte paneles pequeños suplementario</i> | ○ |
| Repetitive cutting device of horizontal strips <i>Dispositivo de cortes repetitivos de bandas horizontales</i> | ○ |
| Scoring unit with 2 H.M. Knives <i>Grupo incisor con 2 cuchillas</i> | ✕ |
| Scoring unit with split saw blade <i>Grupo incisor de doble sierra</i> | ● |
| Electronic vertical measuring display <i>Medidor digital para posición verticales</i> | ○ |
| Electronic horizontal measuring display <i>Medidor digital para posición horizontales</i> | ○ |
| Sliding support for narrow pieces <i>Apoyo deslizable para piezas pequeñas</i> | ● |
| Dust catcher for horizontal cuttings TRK <i>Conductor de polvo para los cortes horizontales TRK</i> | ○ |
| Adjustable thickness stop <i>Tope de profundidad</i> | ○ |
| Angle cutting device <i>Dispositivo de corte inclinado</i> | ○ |
| Kit V-grooving with adjustable thickness stop <i>Dispositivo Alu con tope de profundidad</i> | ○ |

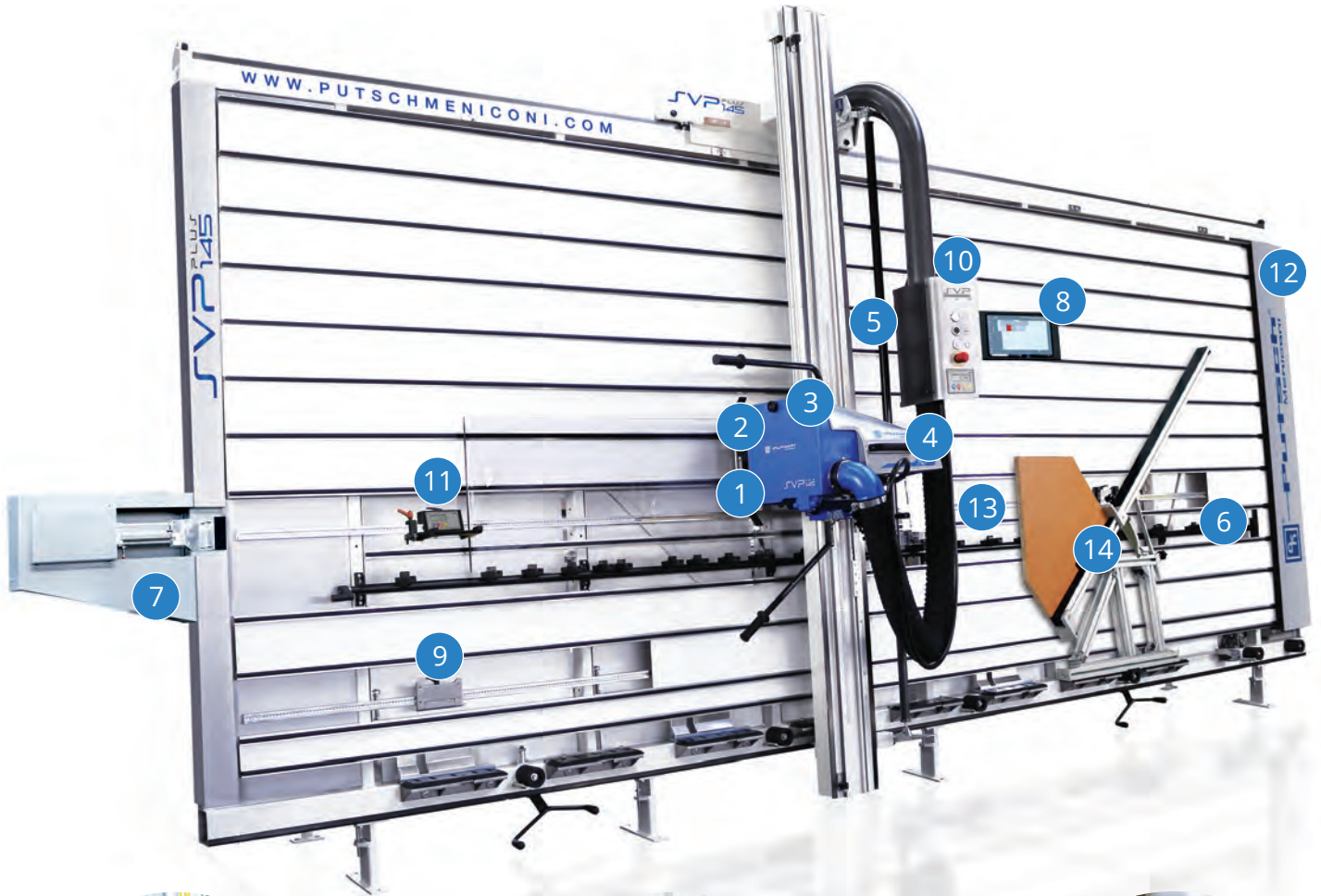

Saw head for scoring unit with split saw blades
Cabezal con incisor de doble sierra



New saw head SVP 145 plus
Nuevo cabezal SVP145 plus



Repeat cutting device of horizontal strips
Dispositivo de cortes repetitivos horizontales



Low level stop
Tope suplementario abajo



Electronic horizontal measuring display
Medidor digital para posición horizontal



Electronic vertical measuring display
Medidor digital para posición vertical

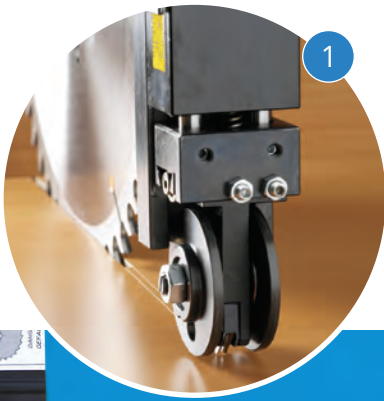

Scoring unit with 2
H.M. Knives
*Grupo incisor con dos
cuchillas*



Scoring unit with split
saw blades
*Grupo incisor de doble
sierra*

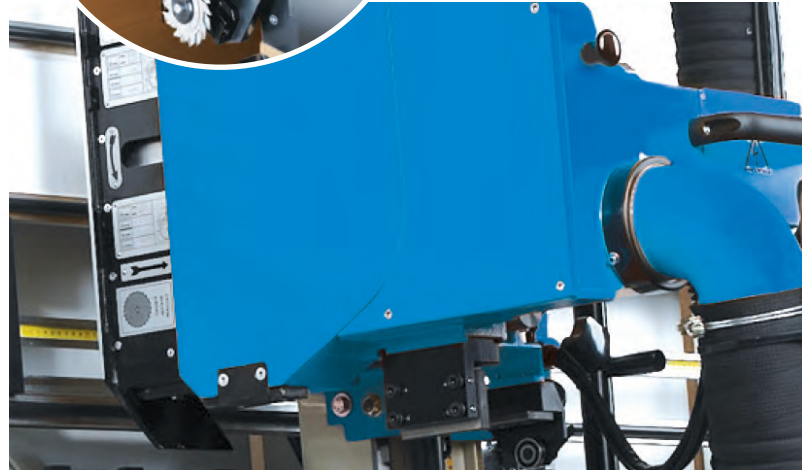
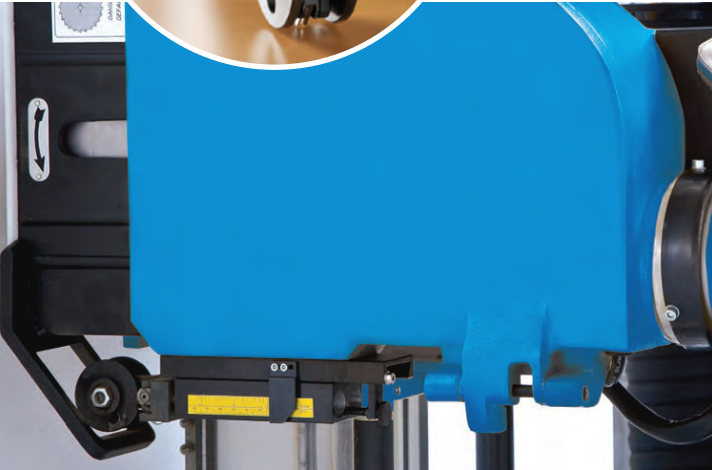

Extra short cutting device
(RH)
*Dispositivo corte paneles
pequeños suplementario*

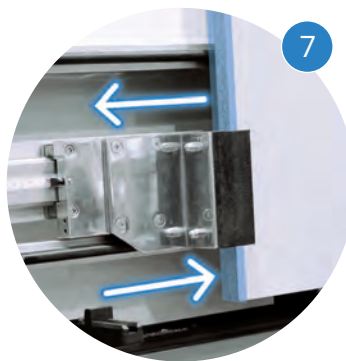

Electronic stop for vertical
cuttings Posi-System
*Tope electrónico para los
cortes verticales Posi-System*



Cut optimizer Putsch Label
on board
*Optimizador de cortes a bordo
de la maquina*



Dust catcher for horizontal
cuttings TRK
*Conductor de polvo para los
cortes horizontales TRK*



Sliding support for narrow pieces
Apoyo deslizable para piezas pequeñas



Angle cutting device
Dispositivo para corte inclinado

PACKAGE / EMBALAJE



BEAM PACKAGE / EMBALAJE BANCADA

* with scoring blade
* con incisor de doble sierra

| MACHINE MAQUINA | A (cm) | B (cm) | H (cm) | WEIGHT (kg) PESO (kg) |
|--------------------|-----------|--------|----------|--------------------------|
| SVP 133 BABY | 290 | 113 | 75 | 410 / 450 |
| SVP 133 / 133* | 290 / 310 | 113 | 75 / 115 | 450 / 490 |
| SVP 145 / 145* | 290 / 310 | 113 | 75 / 115 | 460 / 500 |
| SVP 145 ECO | 290 | 113 | 115 | 500 |
| SVP 145 A / ECO | 310 | 113 | 115 | 540 / 580 |
| SVP 320 / ECO | 310 | 113 | 115 | 490 |
| SVP 420 / A / ECO | 310 | 113 | 115 | 500 |
| SVP 420 CS H | 330 | 113 | 115 | 650 |
| SVP 420 A CS H | 330 | 113 | 115 | 650 |
| SVP 950 / ECO | 310 | 113 | 115 | 580 / 620 |
| SVP 950 A / ECO | 310 | 113 | 115 | 660 / 730 |
| SVP 980 AT / ECO | 310 | 130 | 110 | 1060 / 1100 |



FRAME PACKAGE / EMBALAJE BASTIDOR

* with scoring blade
* con incisor de doble sierra

| FRAMES BASTIDORES | A (cm) | B (cm) | H (cm) | WEIGHT (kg) PESO (kg) |
|----------------------|--------|--------|--------|--------------------------|
| SVP 133 BABY | 407 | 22 | 170 | 290 / 325 |
| SVP 133 / 133* | 483 | 22 | 200 | 350 |
| SVP 145 / 145* | 561 | 22 | 235 | 450 |
| SVP 145 ECO | 561 | 22 | 235 | 500 |
| SVP 145 A / ECO | 561 | 22 | 235 | 480 |
| SVP 320 / A / ECO | 483 | 22 | 200 | 350 |
| SVP 420 / A / ECO | 561 | 22 | 235 | 500 |
| SVP 420 CS H | 563 | 45 | 270 | 550 |
| SVP 420 A CS H | 563 | 45 | 270 | 550 |
| SVP 950 / ECO | 657 | 25 | 235 | 535 / 590 |
| SVP 950 A / ECO | 657 | 25 | 235 | 535 / 590 |
| SVP 980 AT / ECO | 690 | 25 | 235 | 610 / 650 |

Technical details and pictures are only indicative. The manufacturer reserves the right to carry out modifications without prior notice.
Los datos técnicos y imágenes son indicativas. El constructor se reserva el derecho de aportar cambios sin ningún preaviso.

WOOD / MADERA



Chipboard
Conglomerados

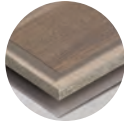

Melamine panels
Melaminicos



Solid Wood
Madera Maciza

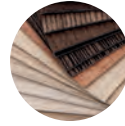

Laminated
Laminados



Plywood
Contrachapado

COMPOSITES / COMPOSITES



Panels HPL
Paneles HPL



Sandwich
Sandwich



Reynobond®
Reynobond®

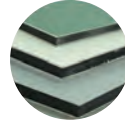

Etabond®
Etabond®

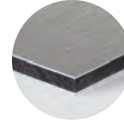

Dibond®
Dibond®

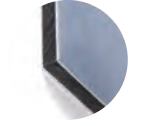

Alupanel®
Alupanel®

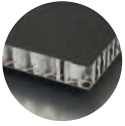

Alucore®
Alucore®

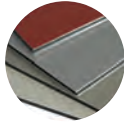

Alucobond®
Alucobond®

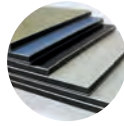

Panels ACM-ACP
Paneles ACM-ACP

PLASTICS / PLASTICOS



Plastics Materials
Materiales plasticos



Polypropylene
Polipropileno

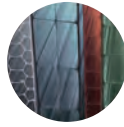

Polycarbonate
Policarbonato



Plexiglass
Plexiglass



Forex
Forex

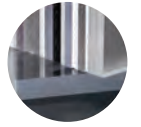

Methacrylate
Metacrilato

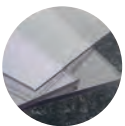

Makrolon®
Makrolon®

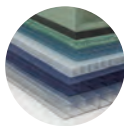

Lexan®
Lexan®



Plastic Laminates
Laminados Plasticos



PVC
PVC

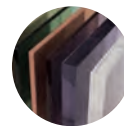

Acrylic
Acrílico

SPECIAL / ESPECIALES



Honeycomb
Paneles de nidos de abeja

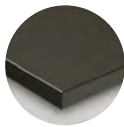

Trespa®
Trespa®



Fiberglass
Fibra de vidrio



Polyurethane
Poliuretano

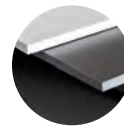

Corian®
Corian®



Plasterboard
Pladur



Insulated
Paneles Aislantes

visit our web site



putschmeniconi.com

Putsch[®] Meniconi S.p.A.

Via Irlanda 1, 53036 POGGIBONSI (SI) Italy
Tel. +39 0577 90311 | Fax. +39 0577 979335
www.putschmeniconi.com | info@putschmeniconi.com

All rights reserved
2019
Art direction and photo
Studio Massimo Marziali S.r.l.
Printed by *Tap Grafiche S.r.l.*



facebook.com/verticalpanelsaw



instagram.com/putsch_meniconi_spa



plus.google.com/+PutschMeniconiSpa



youtube.com/user/PutschMeniconi



linkedin.com/company/putsch-meniconi